

Pressure Reducing Valves

X(C)G2V-6/8, 10 Series

Typical Section

X(C)G2V-***-1* valve

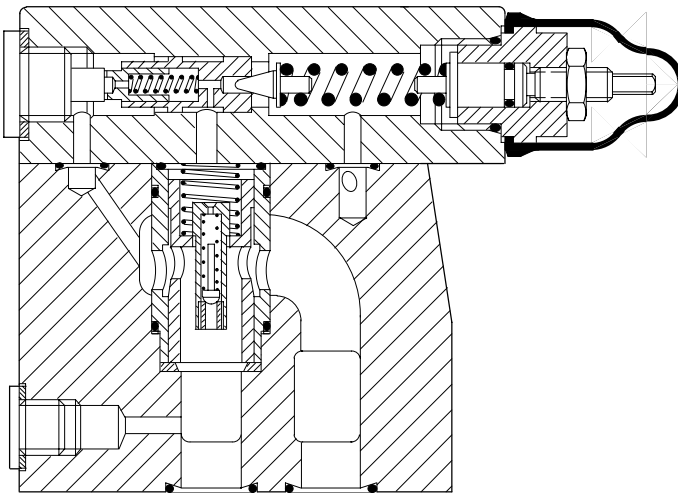

High valve response ensures that the reduced outlet pressure is unaffected by inlet pressure peaks. Excessive build-up of outlet port pressure (e.g. caused by flow back from an actuator) is prevented by the small check in the main-stage which connects the outlet port to the pilot stage.

For applications where full reverse flow is required an optional integral check valve is available (model types XCG).

Models with electrohydraulic proportional control, types KX(C)GV, are described in catalog 2322.

Features and Benefits

- Close matching to machine requirements with choice of five adjustment ranges of reduced pressure.
- Excellent repeatability and stable performance results from cartridge design of main-stage parts.
- Minimal pump flow losses when using several valves in parallel, results from design of internal pilot system.
- Free reverse flow from integral check valve option.
- International mounting surfaces.
- Low installed cost and space requirement from high power/size ratios (more than double that of many conventional designs).

Basic Characteristics

Max. inlet pressure 350 bar
	(5000 psi)
Max. reduced pressure 330 bar
	(4780 psi)
Maximum flow	.. 300 L/min (80 USgpm)
Mounting face to ISO 5781	
(B port high pressure inlet):	
X(C)G2V-6 AG-06-2-A
X(C)G2V-8 AH-08-2-A

General Description

Where sections of an hydraulic system are required to operate at a pressure below that of the general system, it is frequently more convenient to use a pressure reducing valve than to add further pump sections.

These two-stage pressure reducing valves allow full flow from inlet to outlet port until the reduced pressure setting is reached, whereupon the outlet flow is closed off. Reduced pressure setting is manually adjustable at the pilot stage. Five ranges of reduced pressure adjustment are available.

Functional Symbols

XG2V model (no reverse flow check)

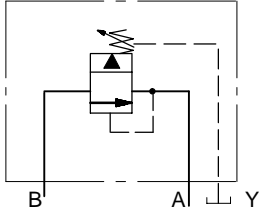

XCG2V model (integral check valve for free flow A to B)

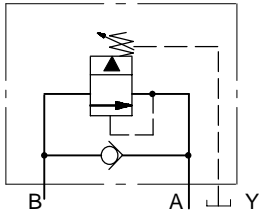

Model Code

For valves with manual adjustment only

(F3-)X(C)G2V- * * * -1*



1 Fluid compatibility

Blank = Anti-wear hydraulic oil (class L-HM), invert emulsion (class L-HFB) or water glycol (class L-HFC)

F3 = As above or phosphate ester (class L-HFD)

2 Integral check valve (free reverse flow)

C = Integral check valve
Omit if not required

3 Mounting surface, ISO 5781

With B port, high pressure inlet and A port, reduced pressure outlet

6 = Size 06

8 = Size 08

4 Reduced pressure adjustment control range

A = 2 to 35 bar (30 to 500 psi)

B = 5 to 70 bar (44 to 1000 psi)

C = 5 to 140 bar (44 to 2000 psi)

F = 5 to 210 bar (44 to 3000 psi)

G = 5 to 330 bar (44 to 4780 psi)

5 Type of manual adjustment

K = Micrometer with keylock

M = Micrometer without keylock

W = Screw/locknut

6 Design number, 1* series

Subject to change. Installation dimensions unaltered for design numbers 10-19 inclusive.

Operating Data

Data is typical with oil at 22 cSt (106 SUS) and at 50°C (122°F).

Maximum pressures:	
Port B (pressure inlet)	350 bar (5000 psi)
Port A (reduced pressure outlet)	See model code position 4
Port Y ■	2 bar (30 psi)
Rated flow rates at $\Delta p = 12$ bar (175 psi):	
X(C)G2V-6	200 L/min (53 USgpm)
X(C)G2V-8	300 L/min (80 USgpm)
Pressure adjustment ranges	See model code position 4
Minimum pressure differential ($P_B - P_A$) for effective reduced pressure control, all models	20 bar (300 psi) approx.
Pilot control drain flow, all models	
at P_B 100 bar (1450 psi)	1,0 L/min (0.26 USgpm)
at P_B 300 bar (4350 psi)	1,3 L/min (0.34 USgpm)
Hydraulic fluids and fluid temperatures	See page 3
Temperature limits	See page 3
Mass	See page 6
Spare parts/service information	40630

■ Back pressure at this port is additive to the reduced pressure setting of the valve.

Pressure Underride

X(C)G2V-8 examples

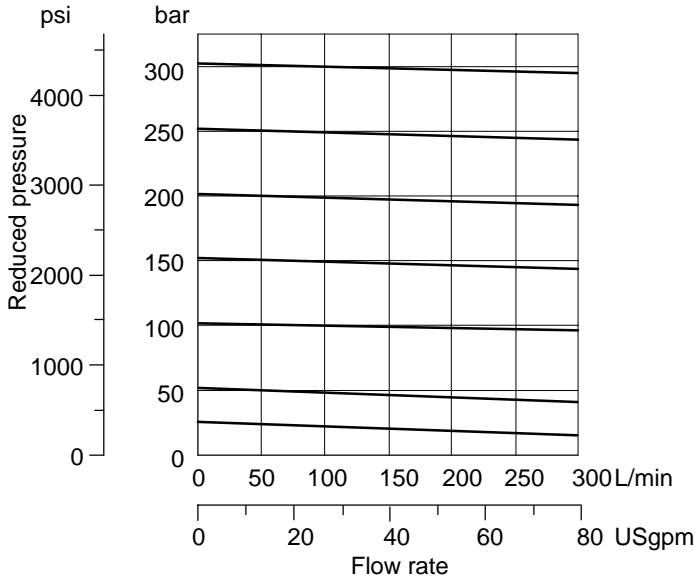

Pressure Drop

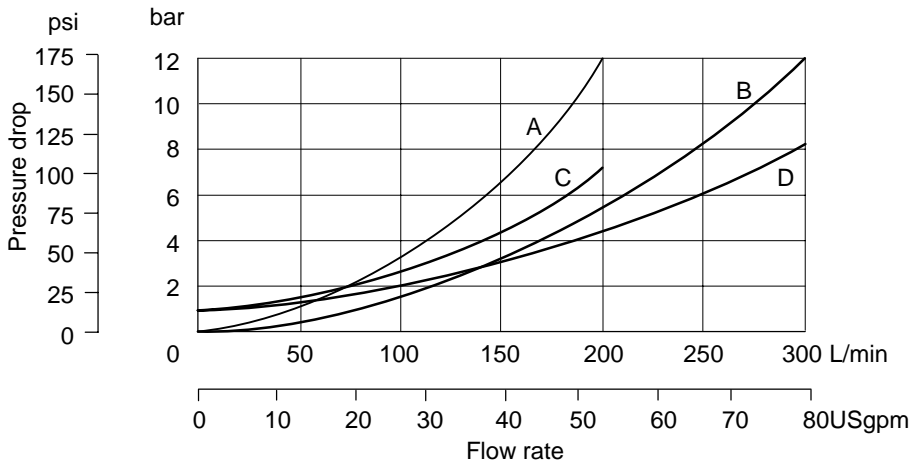

From port B to A at pressures below reduced pressure setting:

- X(C)G2V-6 Curve A
- X(C)G2V-8 Curve B

From port A to B through check valve (main stage assumed closed), XCG2V models only:

- XCG2V-6 Curve C
- XCG2V-8 Curve D

Hydraulic Fluids

All valves can be used with:
 Anti-wear hydraulic oils (class L-HM)
 Invert emulsions (class L-HFB)
 Water glycol (class L-HFC)
 Phosphate ester (class L-HFD), adding "F3-" prefix at model code 1

The extreme viscosity range is from 500 to 13 cSt (2270 to 70 SUS) but the recommended range is 54 to 13 cSt (245 to 70 SUS).

For further information about fluids see catalog 694.

Temperature Limits

Ambient:

- Min. -20°C (-4°F)
- Max. 70°C (158°F)

Fluid temperature:

- Min. -20°C (-4°F)
- Max.* 70°C (158°F)

* To obtain optimum service life from both fluid and hydraulic system, 65°C (150°F) normally is the maximum temperature except for water-containing fluids.

For synthetic fluids consult fluid manufacturer or Vickers representative where limits are outside those of petroleum oil.

Whatever the actual temperature range, ensure that viscosities stay within the limits specified in the "Hydraulic Fluids" section.

Contamination Control Requirements

Recommendations on contamination control methods and the selection of products to control fluid condition are included in Vickers publication 561, "Vickers Guide to Systemic Contamination Control". The book also includes information on the Vickers concept of "ProActive Maintenance". The following recommendations are based on ISO cleanliness levels at 2 µm, 5 µm and 15 µm. For products in this catalog the recommended levels are:

- Up to 210 bar (3050 psi) 19/17/14
- Above 210 bar (3050 psi) 19/17/14

Installation Dimensions in mm (inches)

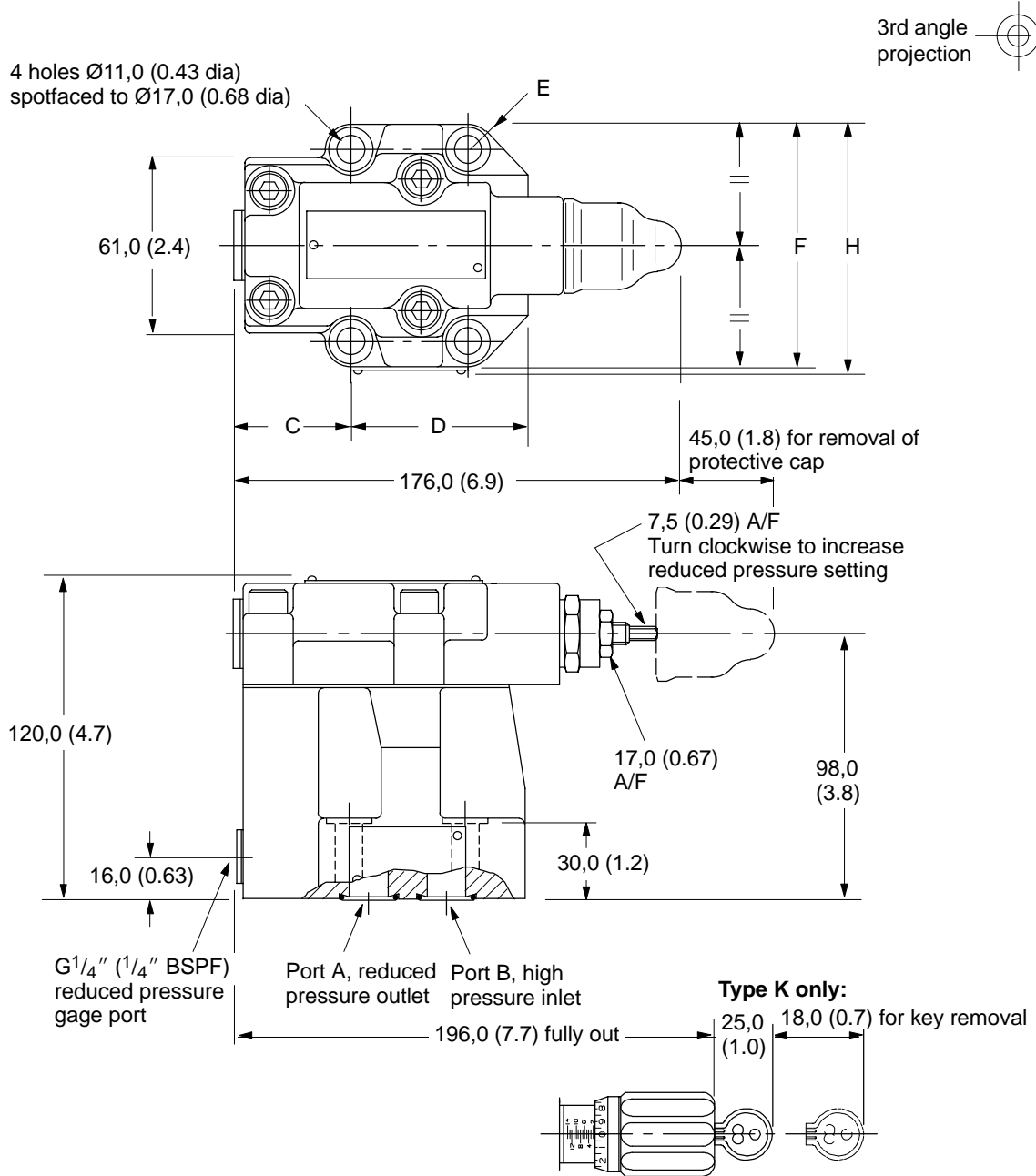

Model	C	D	E	F	H
X(C)G2V-6	42,0 (1.7)	66,0 (2.6)	10,0 (0.4)	89,0 (3.5)	92,0 (3.65)
X(C)G2V-8	40,0 (1.6)	77,0 (3.1)	11,0 (0.43)	104,0 (4.1)	107,0 (4.25)

Micrometer Adjustment Options: "K" or "M" in Model Code 5

"K" Feature

To adjust pressure setting, insert key and turn clockwise. Turn micrometer knob clockwise to increase pressure setting; counter-clockwise to decrease setting.

When the key is removed, the knob can spin freely without affecting the pressure setting.

Views on Bottom Face of Valves (See also "Mounting Surfaces", page 6. All O-seals supplied).

X(C)G2V-6

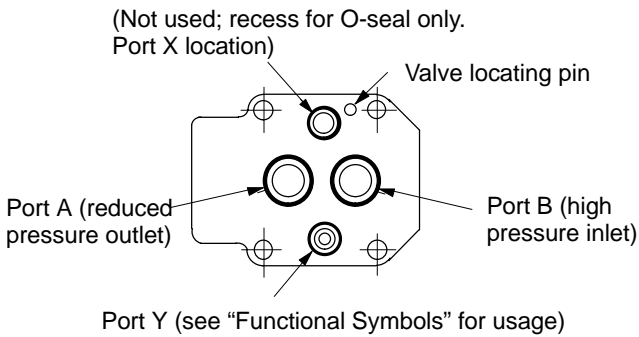

X(C)G2V-8

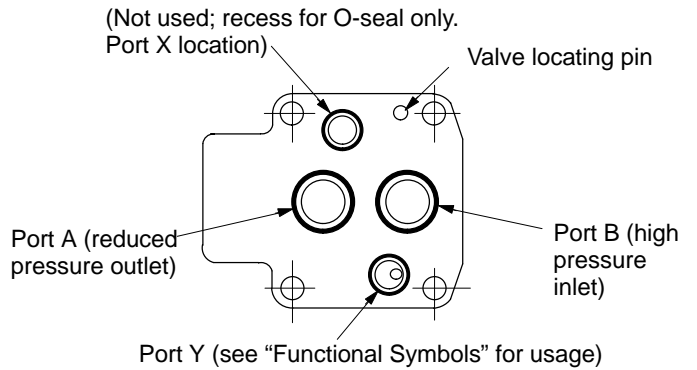

XCGVM-6-10R Subplate

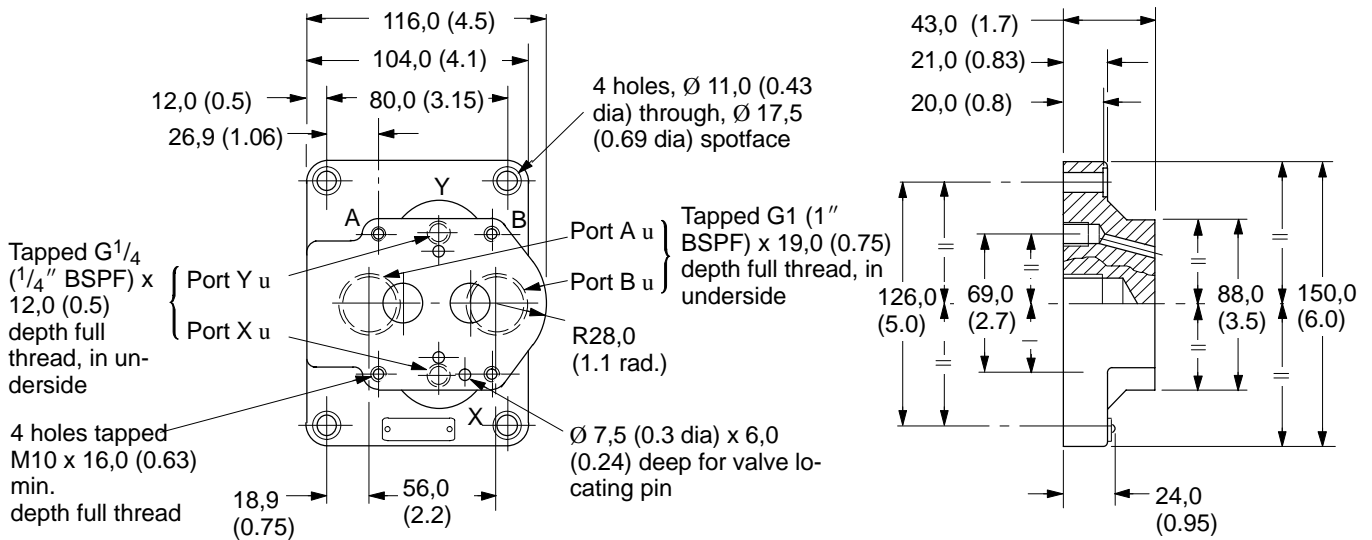

▲ See "Mounting Surfaces" section on next page for port usage.

Mounting Surfaces, Based on

ISO 5781 Codes:

AG-06-2-A

AH-08-2-A

When a subplate is not used a raised machined pad must be provided for mounting. The pad must be flat within 0,01mm/100 mm (0.001"/10") and smooth within 0,8 µm (32 µin).

Dimensional tolerances are ± 0,2 mm (0.008") except where indicated.

Port functions

A = Reduced pressure outlet (also free

reverse flow inlet for XCG2V valves)

B = High pressure inlet (also free reverse flow outlet for XCG2V valves)

X = Not used for X(C)G2V valves; can be omitted or plugged

Y = Drain port

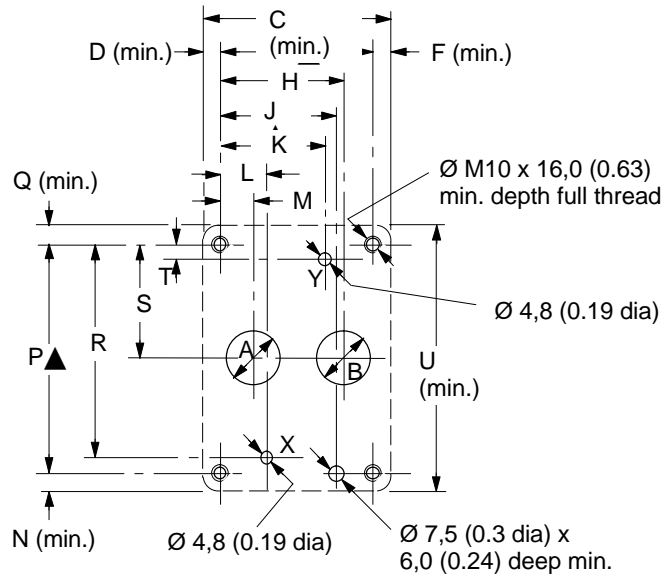

Size	A dia.	B dia.	C	D	E	F	H	J	K
06	14,7 (0.58)	14,7 (0.58)	61,0 (2.4)	9,0 (0.4)	42,9 (1.69)	9,0 (0.4)	35,7 (1.4)	31,8 (1.25)	21,4 (0.84)
08	23,4 (0.92)	23,4 (0.92)	78,0 (3.1)	8,8 (0.35)	60,3 (2.37)	8,8 (0.35)	49,2 (1.94)	44,5 (1.75)	39,7 (1.56)

Size	L	M	N	P	Q	R	S	T	U
06	21,4 (0.84)	7,1 (0.28)	10,0 (0.4)	66,7 (2.62)	10,0 (0.4)	58,7 (2.3)	33,3 (1.3)	7,9 (0.31)	87,0 (3.4)
08	20,6 (0.81)	11,1 (0.44)	10,8 (0.43)	79,4 (3.125)	10,8 (0.43)	73,0 (2.87)	39,7 (1.56)	6,4 (0.25)	101,0 (4.0)

▲ Tolerance on bolt and pin locations
± 0,1 mm (0.004").

Installation Data

Mounting attitude unrestricted

Subplates

For X(C)G2V-6 valves see type XCGVM-6-10R, on page 5.

For X(C)G2V-8 valves consult your Vickers representative.

Mounting Bolts/Torques

For all models, bolt kit BKXG2V-6.

Bolts should be torqued to 59-73 Nm (44-53 lbf ft), with threads lubricated.

Mass

X(C)G2V-6 valves 4,8 kg (10.6 lb)

X(C)G2V-8 valves 5,6 kg (12.4 lb)

Ordering Procedure

All valves, subplates, bolt kits should be ordered by full model code designation.