



ET4000 Crimp Machine

Set Up and Operating Manual

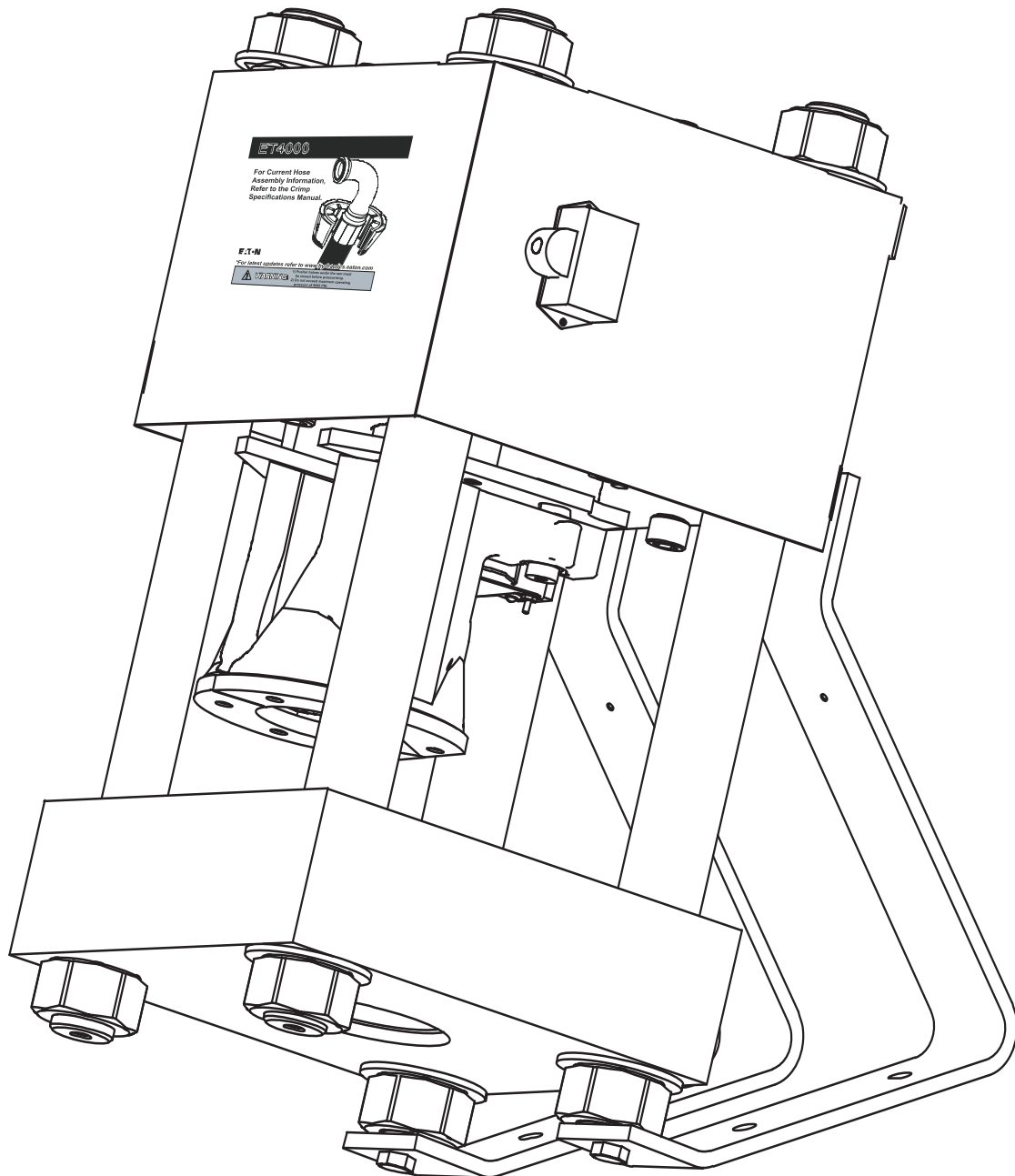

Table of Contents

SECTION

PAGE

Specifications and equipment	3
Shop/work table mounting	4
Check-out procedure	5
Operating instructions (ET4000AR-001)	6
Operating instructions (ET4000AR-002)	7
Operating instructions (T-410-25)	8
Operating Instructions	9
Troubleshooting procedures	10
Repair and replacement items	12

Safety Instructions

Read and understand the operator's manual before attempting to operate any equipment.

WARNING Aeroquip hose, hose fittings and assembly equipment should be used only with other Aeroquip hose, hose fittings and assembly equipment and Weatherhead hose, hose fittings and assembly equipment should be used only with Weatherhead hose, hose fittings and assembly equipment. Do not combine or use Aeroquip or Weatherhead hose, hose fittings and assembly equipment with each other, i.e. Aeroquip hose with Weatherhead fittings, or with hose, hose fittings or assembly equipment supplied by another manufacturer.

Eaton hereby disclaims any obligation or liability (including incidental and consequential damages) arising from breach or contract, warranty, or tort (under negligence or strict liability theories) should Aeroquip **or** Weatherhead hose fittings or assembly equipment be used **interchangeably** or with **any** hose, fittings or assembly equipment supplied by another manufacturer, or in the event that product instructions for each specified hose assembly are not followed.

WARNING Failure to follow process and product instructions and limitations could lead to premature hose assembly failures, resulting in property damage, serious injury or death.

Aeroquip and Weatherhead fitting tolerances are engineered to match Aeroquip and Weatherhead hose tolerances. The combination or use of Aeroquip or Weatherhead hose and hose fittings with each other, i.e. Aeroquip hose with Weatherhead fittings, or with hose or fittings supplied by another manufacturer may result in the production of unreliable and/or unsafe hose assemblies and is neither recommended nor authorized by Eaton.

Safety Instructions

1. PREVENT UNAUTHORIZED OPERATION. Do not permit anyone to operate this equipment unless they have read and thoroughly understand this manual.
2. WEAR SAFETY GLASSES.
3. AVOID PINCH POINTS. Do not rest your hand on the crimp ring. Keep your hands clear of all moving parts. Do not allow anyone, other than the operator, close to the equipment while it is in operation.

4. MAINTAIN DIES WITH CARE. Dies used in the ET4000 crimp machine are hardened steel, offering the best combination of strength and wear resistance for long life. Hardened dies are generally brittle and care should be taken to avoid any sharp impact. Never strike a die with a hardened instrument.
5. USE ONLY SPECIFIED AEROQUIP/WEATHERHEAD PRODUCTS. Make hose assemblies using only Aeroquip and Weatherhead hose and fittings specified for this assembly equipment.
6. VERIFY CORRECT CRIMP DIAMETERS. Check and verify correct crimp diameters of all fittings after crimping. Do not put any hose assemblies into service if the crimp diameters do not meet Eaton crimp specifications.
7. Make sure all dies are completely in place, the spacer ring rests against the locator bracket, and the pusher halves are closed before crimping.

8. DO NOT OVER PRESSURIZE. Do not exceed the 5,000 psi hydraulic pressure supplied to the machine.

NOTE: All components used to connect the pump and crimp cylinder must meet the criteria set forth in the Material Handling Institute Specification #IJ100 for hydraulic jacking applications.

9. DIE CHANGE. DO NOT INSERT/REMOVE DIES WHILE THE POWER IS ON OR MACHINE IS IN OPERATION.
10. SECURE THE EQUIPMENT TO A STABLE WORK SURFACE. Prior to operation, secure the crimp machine to a stable work surface to prevent the equipment from tipping. See pages 4-5 for mounting instructions.
11. UNPLUG THE POWER SUPPLY WHEN NOT IN USE.
12. KEEP WORK AREA CLEAN. Cluttered areas and benches invite accidents.
13. DO NOT OPERATE WITHOUT THE BASE ADAPTER RING IN PLACE.

Specifications and Equipment

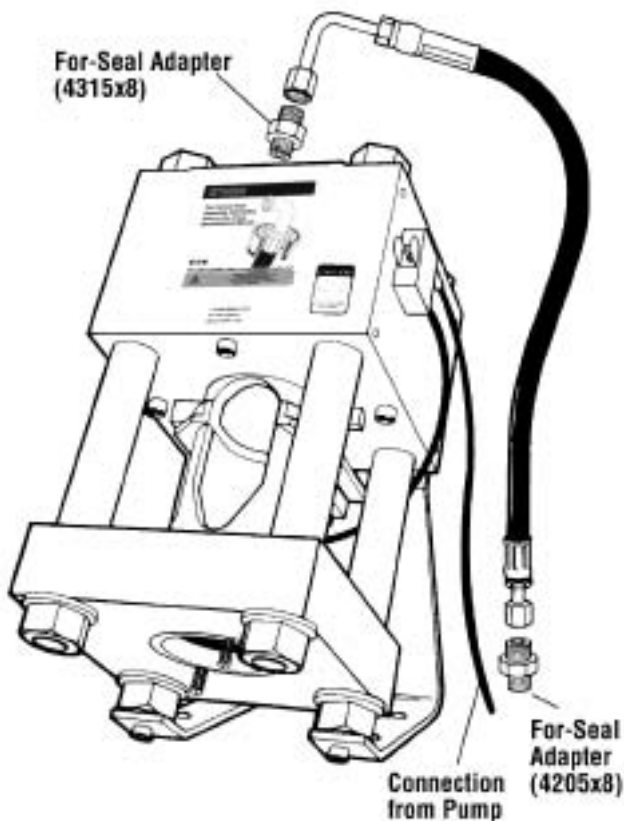

ET4000 Crimp Machine

ET4000 is ideal for factory high performance machine operations, construction and mine locations. The ET4000 press offers the crimping capabilities through 2" I.D. six spiral hose.

Weight: 500 lbs.
Size: 29" high, 21" deep, 12" wide

Interlock Cord Between Pump & Press

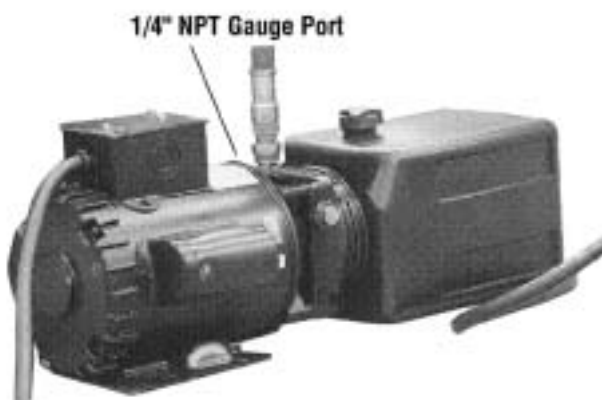

T-441 Electric Pump

The Eaton T-441 power unit is ideally suited for use with the ET4000 press. It features a two-stage pump providing high flow at low pressure for fast ram approach and low flow at high pressure for actual crimping.

Dimensions: 7 1/2" high, 10" wide, 22" long
Weight: 75 lbs.
Pressure: 5000 psi
Reservoir Capacity: 6 Quarts
Outlet Port Size: 3/4-16 straight thread o-ring
Motor: 1HP, 3450 RPM, 220 volts, 60 cycle, single phase
Hydraulic Oil: ISO 32 (SAE 10W)
Flow: 2.6 GPM to 900 psi to
0.6 GPM above 900 psi

⚠ Caution: The T-441 Electric Pump has the relief valve set at 5000 psi. Damage to the press will result and the warranty may be voided if higher pressures are used. Requires 15 amp fused breaker.

Shop/Work Table Mounting

Instructions for Shop/Work Table Mounting

Figure 1 - Bench Layout for ET4000 Press

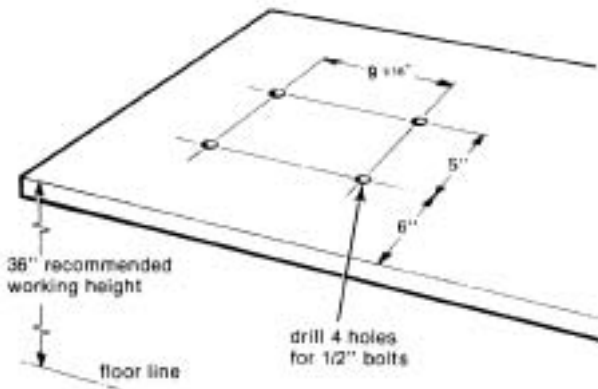

Figure 2 - Lifting Hole Layout on ET4000 Press Top Plate

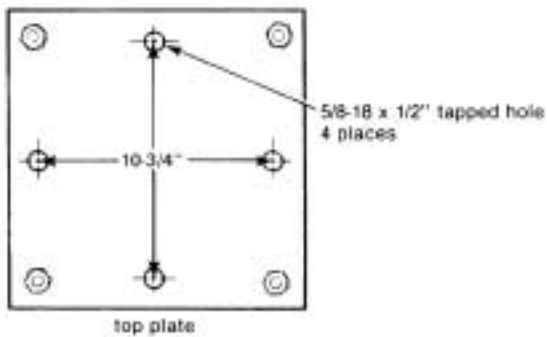
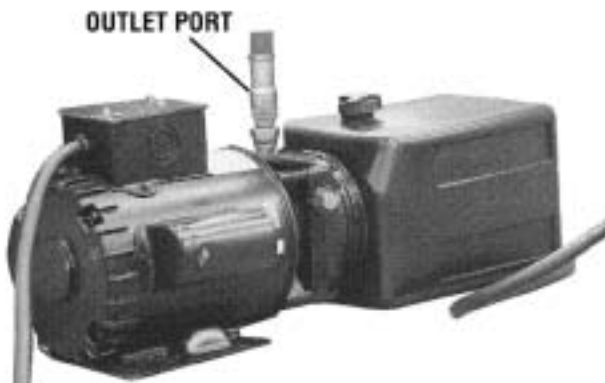

Figure 3 - T-441 Outlet Port



The following methods are offered as a guide and may be varied to suit your particular needs.

1. Prepare mounting surface for ET4000 press and pump. Refer to FIGURE 1 for bolt hole layout and optimum height.

IMPORTANT: Care must be taken to insure that the surface to which the press is bolted is capable of supporting the weight of the press (approximately 500 lbs.) and pump which is 75 lbs.

2. Remove shipping carton from ET4000 press. There are four 5/8-18 tapped holes in top plate which may be used for lifting purposes (see FIGURE 2). If these tapped holes are used, it is recommended that a minimum of two be utilized, preferably four. If two holes are used for lifting, use holes directly across from each other on the center line and not two on a diagonal. This will prevent press from tilting as it is raised.
3. Using an adequate lifting device, raise the press to the mounting surface. Align holes in press support brackets with holes in mounting surface. Insert four 1/2" bolts from top of mounting surface. Washers and nuts are installed from underneath. TIGHTEN.
4. Place the T-441 pump on the mounting surface to the right and slightly behind the ET4000 press. (Reference FIGURE 4, Page 5)
5. Mark power unit base plate hole pattern on mounting surface. Remove power unit and drill holes.
6. Replace pump and align holes on mounting surface with base plate of pump. Insert bolts from top of mounting surface. Washers and nuts are installed from underneath. TIGHTEN.
7. Remove middle plug from outlet port in pump. (See FIGURE 3.)
8. Locate press/pump connecting hose assembly and remove plugs. Connect unions into outlet port in pump and press. TIGHTEN.
9. Remove pipe plug from pump reservoir and replace with breather cap provided.
10. Before the electric pump (T-441) can be activated, the interlock cord must be plugged into the switch box mounted on the ET4000 crimper. After mating the halves of connection, TIGHTEN the knurled nut.
11. Plug electric cord into a grounded (4-wire connection), 220 volt, 60 cycle, single phase outlet. IT IS RECOMMENDED THAT THE PUMP BE ON AN INDIVIDUAL 15 AMP SERVICE OUTLET.

Shop/Work Table Mounting and Check-Out Procedure



 Refer to safety information regarding Eaton hose, hose fittings and assembly equipment compatibility on page 2.

Figure 4 - Typical ET4000 Equipment Set-up on Shop/Work Table.

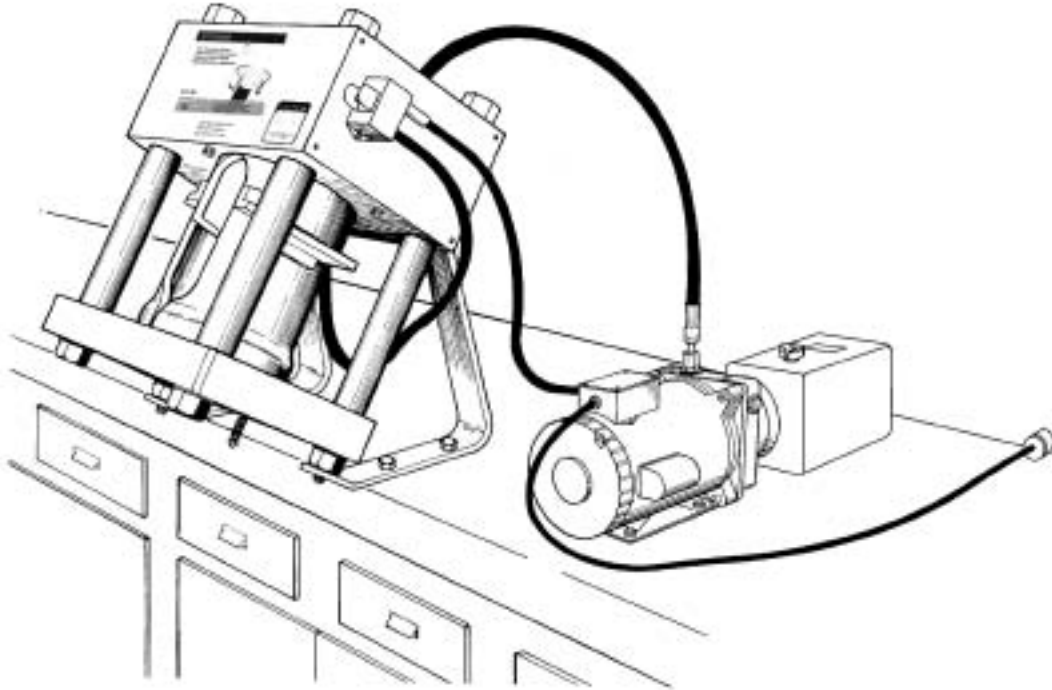

CAUTION: Throughout the Check-out Procedure, check hose assembly/adaptor connections for any leaks. TIGHTEN if necessary. For-Seal Swivel Nut Torque for hose assembly; 32-35 ft. lbs. Check oil lever in power unit. The oil reservoir was filled at the factory, however, if oil is required use ISO 32 (SAE 10W).

 **WARNING:** Do not cycle without base adapter ring in place.

Check-out procedure for using electric pump T-441.

1. Plug electric cord into a grounded (4 wire connection), 220 volt, 60 cycle, single phase outlet. IT IS RECOMMENDED THAT THE PUMP BE ON AN INDIVIDUAL 15 AMP SERVICE OUTLET.
2. To completely purge the hydraulic system, the ram return stops should be in the "out" position to permit the ram to return to the full upright position. (See page 8, Step 1 for the procedure.)
3. Close pusher halves on press. Due to safety interlock switch, power unit will operate only when pusher halves are closed.
4. Hold switch "ON" until pusher touches the base adapter ring.
5. RELEASE SWITCH. Pump will stop and pusher will retract.
6. REPEAT STEPS 4 & 5 APPROXIMATELY SIX TIMES. This will purge the hydraulic system.

Operating Instructions Using ET4000AR-001

 Refer to safety information regarding Eaton hose, hose fittings, and assembly compatibility on page 2.

Eye protection required when press and pump are in use.

NOTE: Based on the fitting style, correctly align the fitting with the top of the collet.

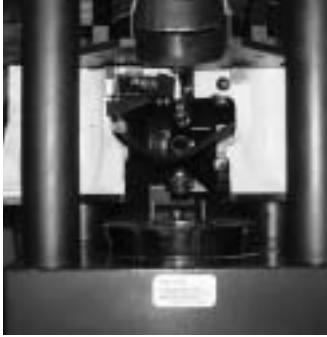

1. OPEN the pusher halves. Select the proper collet assembly for hose type being crimped as referenced in the Crimp Specifications Manual and insert the collet assembly into the base adapter ring.



2. INSERT the hose assembly through the bottom of the base adapter ring and between the two collet assembly halves. Align the fitting with the top of the collet halves as referenced in the Crimp Specifications Manual.



3. PLACE the spacer ring (if applicable) in the appropriate position on top of the collet assembly (either flat-side up or flat-side down as referenced in the Crimp Specifications Manual).

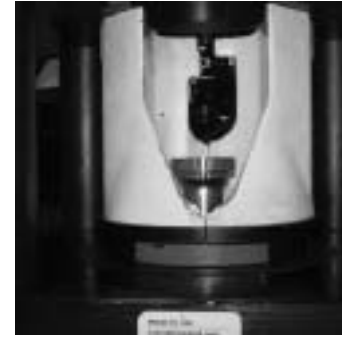

4. CLOSE the pusher halves and begin crimping by activating the pump with turning on the switch. When the pusher halves or spacer ring (if applicable) contacts the base adapter ring, the crimp is complete.

NOTE: Lubricate the inside cone of the base adapter ring and external surfaces of the collet assembly with a high-efficiency PTFE based lubricant.

5. RELEASE the switch and the pusher will automatically return. OPEN the pusher halves and remove the crimped hose assembly.

6. Visually inspect the crimp and verify the correct crimp diameter and length.

Operating Instructions (-20 thru -32 Collets) for Heavy 4-Wire and 6-Wire Fittings Using ET4000AR-002

 Refer to safety information regarding Eaton hose, hose fittings, and assembly compatibility on page 2.

Eye protection required when press and pump are in use.

NOTE: Based on the fitting style, correctly align the fitting with the top of the collet.



1. OPEN the pusher halves.



2. PULL the pusher knob upward. The pusher knob is located behind the top of the pushers near the back of the machine.



3. SLIDE pushers to side while holding the pusher knob up.



5. REMOVE the base adapter ring from base plate and PLACE the ET4000AR-002 base adapter ring inside the base plate.

4. PULL spacer ring locator bracket upward. TURN the locator bracket 90°.

NOTE: Lubricate the outside diameter of base adapter ring before placing into the base plate.

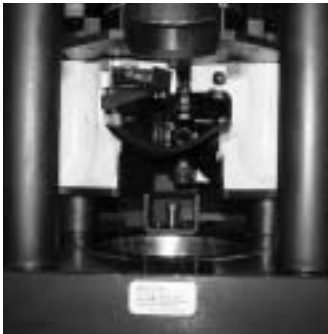

6. TURN locator bracket 90° until aligned properly.

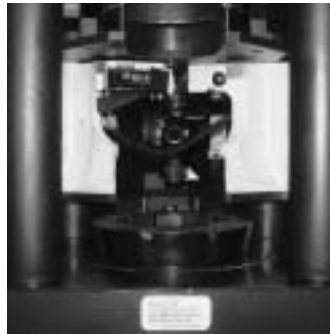

7. SELECT the proper collet assembly for hose type being crimped as referenced in the Crimp Specifications Manual and insert the collet assembly into the base adapter ring.

NOTE: Lubricate the inside cone of the base adapter ring and external surfaces of the collet assembly with a high-efficiency PTFE-based lubricant.



8. INSERT the hose assembly through the bottom of the base adapter ring and between the two collet assembly halves. Align the fitting with the top of the collet halves as referenced in the Crimp Specifications Manual.



9. CLOSE the pusher halves and begin crimping by activating the pump with turning on the switch. When the pusher halves or spacer ring (if applicable) contacts the base adapter ring, the crimp is complete.

10. RELEASE the switch and the pusher will automatically return. OPEN the pusher halves and remove the crimped hose assembly.

11. Visually inspect the crimp and verify the correct crimp diameter and length.

Operating Instructions Using T-410-25 Adapter Ring

 Refer to safety information regarding Eaton hose, hose fittings, and assembly compatibility on page 2.

Eye protection required when press and pump are in use.

NOTE: Based on the fitting style, correctly align the fitting with the top of the collet.



1. HOLD SWITCH "ON": As ram starts downward, rotate the ram return stops outward from their inward position. RELEASE SWITCH. Ram will return to the full upright position allowing enough clearance for insertion of required tooling.



2. OPEN pusher halves and place T-410-25 adapter ring in the base adapter ring (ET4000AR-001).

NOTE: Lubricate the inside cone of the base adapter ring and external surfaces of the collet assembly with a high-efficiency PTFE-based lubricant.



3. SELECT proper size collet (referenced in the Crimp Specifications Manual) for hose type and size being crimped. INSERT collet halves into adapter ring. PLACE proper size hose end on hose. Be sure to bottom the hose.



4. SELECT PROPER spacer ring referenced in the Crimp Specifications Manual. INSERT hose assembly from below, between collet halves.

Place appropriate side of spacer ring on top of collet with uncrimped hose assembly held in place.



5. CLOSE pusher halves. HOLD SWITCH ON. When spacer ring (shown here in black) bottoms on adapter ring below it, the crimp is complete.

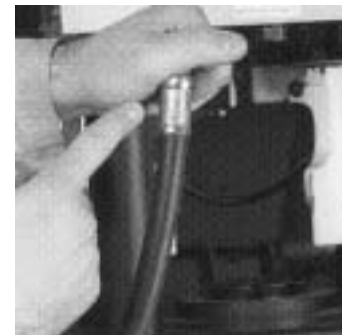

6. RELEASE SWITCH to shut off pump and retract pusher halves. OPEN pusher halves. Remove factory crimped hose assembly and inspect the crimp.

Visually inspect the crimp and verify the correct crimp diameter and length.



FIGURE 8 (BELOW)
Coll-O-Crimp Spacer Ring

Typical spacer ring illustrating both sides of ring

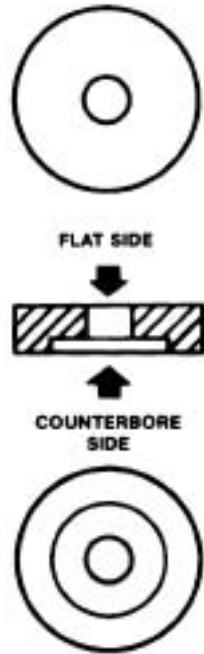
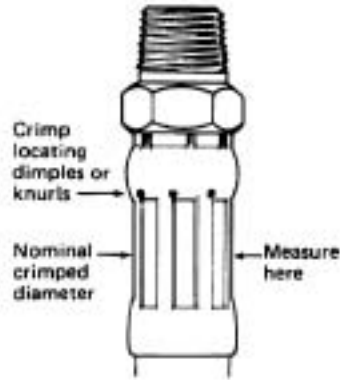

FIGURE C (ABOVE)
Nominal Crimp Diameter Measurement

Measuring crimp diameters should be a part of the normal hose assembly procedure. To insure a proper crimp diameter reading, follow these steps:

1. Measure the diameter in the middle of the crimped portion of the hose end.
2. Place the caliper in a position to allow for a measurement across the pressed (flat) portion of the crimp.
3. See crimp diameters in Crimp Specifications Manual.



Maintenance

Collet Assembly Lubrication:

Every 30 crimps = Re-lubricate sliding surfaces of dies

Every 250 crimps = Remove old grease and re-lubricate

Base Adapter Ring Lubrication:

Every 250 crimps = Remove old grease and re-lubricate

Every 1,000 crimps = Remove old grease, inspect for wear or damage and re-lubricate if okay.

Troubleshooting Procedures

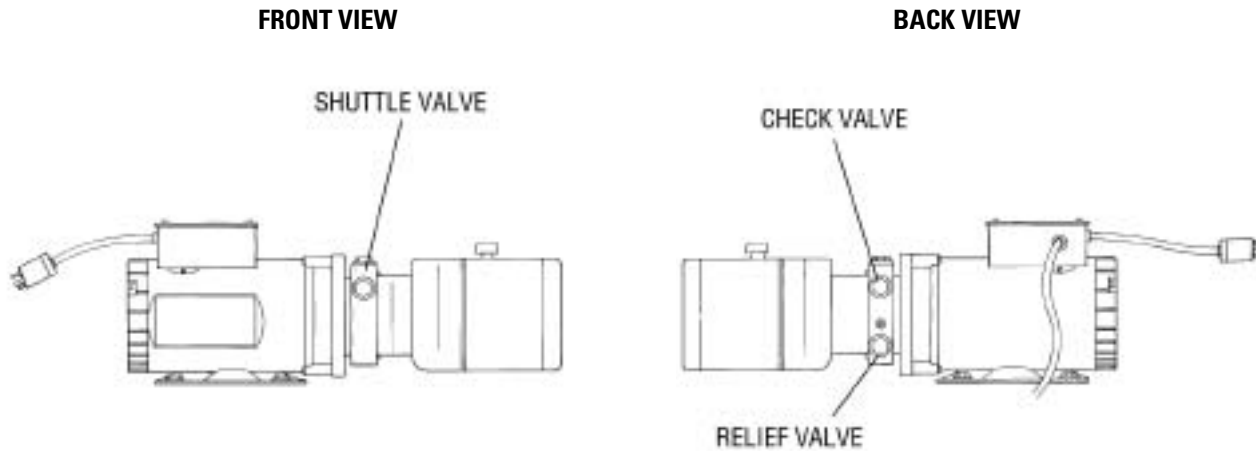

Troubleshooting the Eaton T-441 Electric Pump

PROBLEM	CAUSE	SOLUTIONS (PAGE 11)
Pump/motor does not start	Blown fuse; Improper electrical hookup (cut cord, loose wire, switch malfunctions)	Step #1
Motor starts but blows fuses	High Amps; Pusher doesn't advance; Pump binding or scored; Cold oil	Step #1 Replace Pump
Motor runs - Pusher does not advance	Shuttle stuck open; Pump coupling sheared; Pump unload valve stuck open	Step #4 Replace pump
Motor runs - Pusher advances but doesn't develop final crimp pressure, blows fuse	Pump unload valve stuck shut	Replace Pump
Motor runs - Pusher advances but doesn't develop final crimp pressure.	Relief valve leaking; Shuttle valve leaking; Relief valve set low	Step #3 Step #4 Step #3
Pusher won't retract	Shuttle valve stuck closed	Step #4
Erratic Pusher movement	Low oil level; Worn Seal	Step #2, Replace Pump
Noisy pump; On start up only (continuous)	Low room temp. - Oil too thick; Air leaking - Low oil Level	Use lighter weight oil Step #2
Oil temperature hot	Having unit operate at crimping PSI too long; Low oil level: Pump worn (longer cycle time); Leaking relief valve and /or shuttle valve	Operate for 3 seconds at crimp pressure; Step #2, Replace Pump, Step #3, #4

Troubleshooting Procedures

Troubleshooting Eaton T-441 Electric Pump

 **IMPORTANT:** Pressure must be relieved from system before disconnecting hose, installing gauge or removing valves from pump.

Step 1: Look for fuse, loose wire connections, switch malfunctions or damaged cord. Check for proper installation of a 220 volt circuit.

Step 2: Check oil level - after assembly and system has been purged of air, the fluid level should be 1/2" from top of reservoir. Clean, anti-wear type, having a 300 SSU/100° hydraulic oil is recommended (ISO 32 or SAE 10W). Oil is needed to:

1. Transmit power easily through system
2. Lubricate moving parts
3. Provide seal clearances between parts
4. To cool or dissipate heat

Step 3: Clean or reset relief valve - a 6000 PSI pressure gauge, a 5/16" Allen wrench, a 1" socket and a screwdriver are required. Remove cap from relief valve. Remove adjustment screw, spring and ball. Ball should be attached to spring. Check ball and seat for possible scoring. Replace spring and ball in cavity. Insert a small punch through spring against ball. Give punch a moderate tap to seat ball. Return adjustment screw to original position making sure adjustment screw is at least one turn from bottoming. Remove 1/4" NPTF plug from port above check valve and install a 6000 PSI pressure gage. With 6000 PSI pressure gauge in place, operate unit to full crimping position. Gauge should read approximately 5000 PSI. To raise setting, turn screw inward (clockwise); to lower, turn screw outward (counterclockwise) in 1/4 turn increments. After each adjustment, recycle and read gauge for proper setting. Run a cycle of the crimping system for final gauge reading before removing gauge and reinstalling pipe plug.

Step 4: Shuttle Valve - If the shuttle valve is in a closed position and the ET4000 pusher will not retract, it may be helpful to tap the shuttle valve cap several times to dislodge any silt that may be causing the stem to bind. If this does not free the valve and allow the pusher to retract, use extreme caution prior to proceeding with shuttle valve removal as the system is still under pressure. It may be advisable to relieve pressure at a hose connection to avoid an oil bath. After pressure is removed from system, remove cap and valve cartridge. Soak cartridge in a PETROLEUM BASED SOLVENT ONLY (clean Stoddard solvent). Do not use Triethene, Gasoline or Paint Thinner as they will damage the O-Ring Seals. If cartridge disassembly is required use care in removing stem as it has a .0005 metal seal fit. Rotate stem in solvent and push from seat end to remove from cartridge. Do not lose the loose ball. Wash parts in clean solvent and examine for any surface markings. If necessary, polish with a fine crocus cloth. After final cleaning, reassembly cartridge. Shake cartridge and check for free movement of ball and stem. Replace cartridge if not functional at this point. Reassemble shuttle valve into it's cavity and check crimping cycle prior to using system.

Repair and Replacement Items

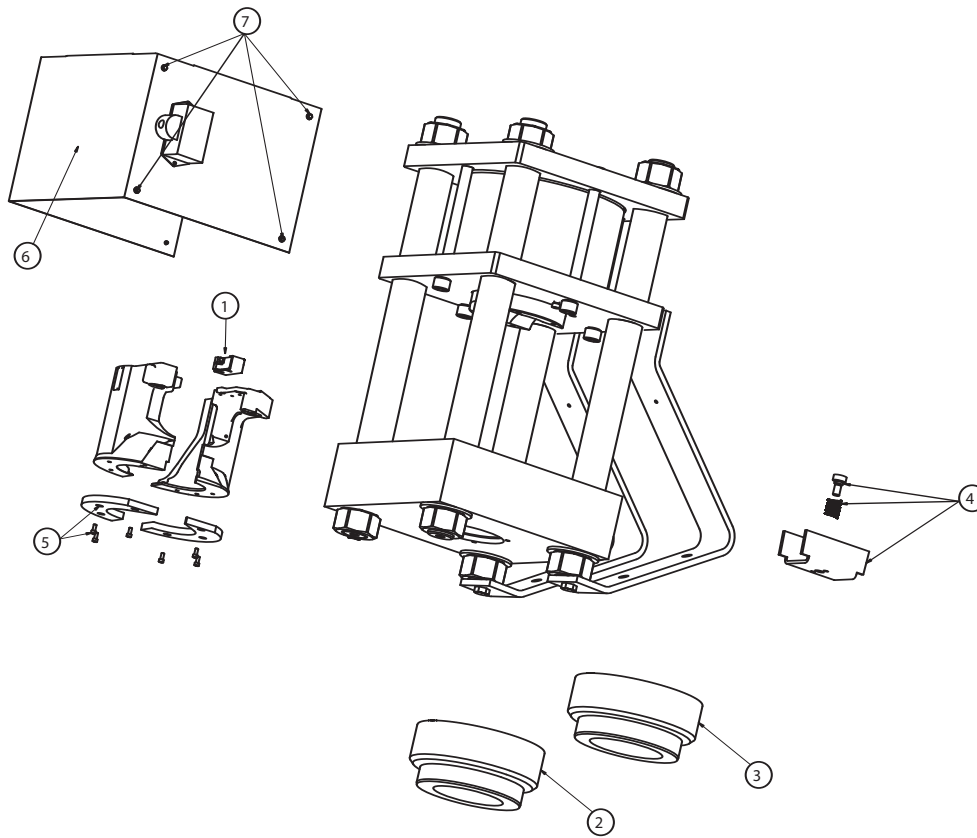

ITEM NUMBER	QTY.	PART NUMBER	DESCRIPTION
1	1	T-410-1M	Micro Switch
2	1	ET4000AR-001	Base Adapter Ring
3	1	ET4000AR-002	Base Adapter Ring
4	1	ET4000TP-001	Locator Bracket Kit
5	1	ET4000TP-002	Wear Plate Kit
6	1	ET4000C-0018/ET4000C-0017	Yellow Shroud / Red Shroud
7	8	120-00429	Screw, Hex Head

Eaton
 14615 Lone Oak Road
 Eden Prairie, MN 55344
 USA
 Tel: 952 937-9800
 Fax: 952 974-7722
www.hydraulics.eaton.com

Eaton
 20 Rosamond Road
 Footscray
 Victoria 3011
 Australia
 Tel: (61) 3 9319 8222
 Fax: (61) 3 9318 5714

Eaton
 Dr.-Reckeweg-Str. 1
 D-76532 Baden-Baden
 Germany
 Tel: (49) 7221 682-0
 Fax: (49) 7221 682-788